

A B C D E F G H

THESE DRAWINGS AND SPECIFICATIONS ARE THE SOLE PROPERTY OF I/O INTERCONNECT INC. U.S.A. AND SHALL NOT BE REPRODUCED, COPIED, OR USED IN ANY MANNER WITHOUT THE PRIOR WRITTEN CONSENT OF I/O INTERCONNECT INC. OR ITS AFFILIATED SUBSIDIARIES.

DWG. NO.	ZONE	REV.	DESCRIPTION	DATE	APPROVED
XX4-52X-D		X1	CUSTOMER APPROVAL	03/26/99	E.V.
		X2	ADD RETRACTED LENGTH	03/29/99	E.V.

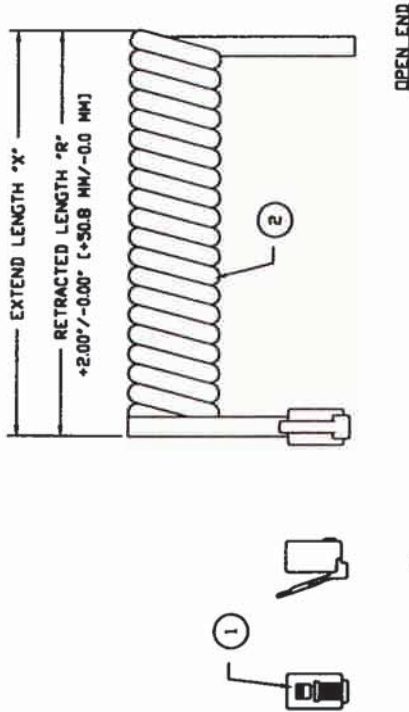

CUSTOMER APPROVAL
 ENGR. SIGN *Matt Jensen*
 DATE: 4-13-99

NOTES: UNLESS OTHERWISE SPECIFIED.

1. TEST CABLE FOR ALL OPENS & SHORTS.
2. PACKAGE CABLE ASSEMBLY INDIVIDUALLY IN PLASTIC BAG. PACKAGE INDIVIDUAL BAG PER LOT NUMBER QUANTITIES.

464-144-525-D	121-410-022	14.0 FT (4.3 M)	34.0 IN (863.6 MM)	WHITE
464-144-524-D	121-410-012	14.0 FT (4.3 M)	34.0 IN (863.6 MM)	BLACK
464-144-523-D	121-410-002	14.0 FT (4.3 M)	34.0 IN (863.6 MM)	SILVER SATIN
464-104-522-D	121-410-021	10.0 FT (3.0 M)	30.0 IN (762.0 MM)	WHITE
464-104-521-D	121-410-011	10.0 FT (3.0 M)	30.0 IN (762.0 MM)	BLACK
464-104-520-D	121-410-001	10.0 FT (3.0 M)	30.0 IN (762.0 MM)	SILVER SATIN
464-074-525-D	121-410-020	7.0 FT (2.1 M)	21.0 IN (533.4 MM)	WHITE
464-074-524-D	121-410-010	7.0 FT (2.1 M)	21.0 IN (533.4 MM)	BLACK
464-074-523-D	121-410-000	7.0 FT (2.1 M)	21.0 IN (533.4 MM)	SILVER SATIN
464-054-525-D	121-410-023	5.0 FT (1.5 M)	17.0 IN (431.8 MM)	WHITE
464-054-521-D	121-410-013	5.0 FT (1.5 M)	17.0 IN (431.8 MM)	BLACK
464-054-520-D	121-410-003	5.0 FT (1.5 M)	17.0 IN (431.8 MM)	SILVER SATIN
IOI PART NUMBER	IOI CABLE PART NUMBER	EXTENDED LENGTH *X*	RETRACTED LENGTH *R*	COLOR

TABULATION BLOCK

2	*X* FT	IOI	SEE "TABULATION BLOCK"	MODULAR COIL CABLE, 26 AVG (7/34) BARE COPPER, 4 CONDUCTOR, UNSHIELDED, PVC JACKET, (SEE TABULATION BLOCK FOR COLOR).
1	1 PC	IOI	325-641-50X	CONNECTOR, MODULAR PLUG, 6 POSITION, 4 CONDUCTOR, 50U AU, FLAT TYPE EXIT.
ITEM	QTY	MFG.	IOI PART NO.	DESCRIPTION
CABLE ASSEMBLY PARTS LIST				
<p>THIRD ANGLE PROJECTION</p> <p>UNLESS OTHERWISE NOTED, DIMENSIONS ARE IN INCHES (MILLIMETER) TOLERANCES: .XXX ± 0.25 (6.35)</p>				
<p>I/O INTERCONNECT SANTA ANA, CALIFORNIA</p>		<p>TITLE: 6P4C COIL CABLE TO OPEN END, CABLE ASSEMBLY</p> <p>PART NO: 464-XX4-52X-D</p> <p>DWG NO: 464-XX4-52X-D</p> <p>CUSTOMER: DIGI KEY</p> <p>SCALE: NONE</p> <p>SHEET 1 OF 1</p>		

A B C D E F G H

THESE DRAWINGS AND SPECIFICATIONS ARE THE SOLE PROPERTY OF I/O INTERCONNECT INC. U.S.A. AND SHALL NOT BE REPRODUCED, COPIED, OR USED IN ANY MANNER WITHOUT THE PRIOR WRITTEN CONSENT OF I/O INTERCONNECT INC. OR ITS AFFILIATED SUBSIDIARIES.

DWG. NO.	ZONE	REV.	DESCRIPTION	DATE	APPROVED
XX4-SIX-D		X1	CUSTOMER APPROVAL	03/26/99	E.V.
		X2	ADD RETRACTED LENGTH	03/29/99	E.V.

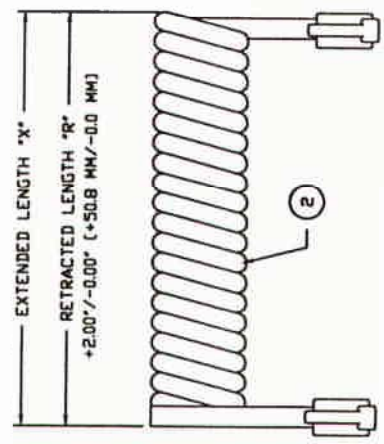

WIRE DIAGRAM

E1		P2
2	BLACK	5
3	RED	4
4	GREEN	3
5	YELLOW	2

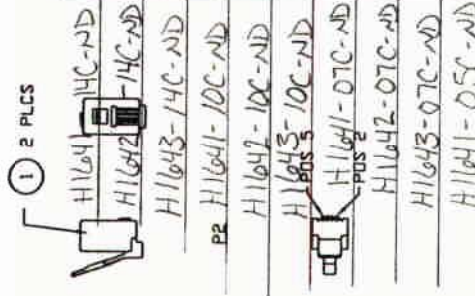

CUSTOMER APPROVAL H1642-D5C-N6
 ENGR. SIGN *Matt J. Lerner* H1643-ASC
 DATE: 4-13-99

- NOTES: UNLESS OTHERWISE SPECIFIED.
- TEST CABLE FOR ALL OPENS & SHORTS.
 - PACKAGE CABLE ASSEMBLY INDIVIDUALLY IN PLASTIC BAG. PACKAGE INDIVIDUAL BAG PER LOT NUMBER QUANTITIES.

IOI PART NUMBER	IOI CABLE PART NUMBER	EXTENDED LENGTH "X"	RETRACTED LENGTH "R"	DESCRIPTION	DATE	APPROVED
464-144-515-D	121-410-022	14.0 FT (4.3 M)	34.0 IN (863.6 MM)	34.0 IN (863.6 MM)	03/26/99	E.V.
464-144-514-D	121-410-012	14.0 FT (4.3 M)	34.0 IN (863.6 MM)	34.0 IN (863.6 MM)	03/26/99	E.V.
464-144-513-D	121-410-002	14.0 FT (4.3 M)	34.0 IN (863.6 MM)	34.0 IN (863.6 MM)	03/26/99	E.V.
464-104-512-D	121-410-021	10.0 FT (3.0 M)	30.0 IN (762.0 MM)	30.0 IN (762.0 MM)	03/26/99	E.V.
464-104-511-D	121-410-011	10.0 FT (3.0 M)	30.0 IN (762.0 MM)	30.0 IN (762.0 MM)	03/26/99	E.V.
464-104-510-D	121-410-001	10.0 FT (3.0 M)	30.0 IN (762.0 MM)	30.0 IN (762.0 MM)	03/26/99	E.V.
464-074-515-D	121-410-020	7.0 FT (2.1 M)	21.0 IN (533.4 MM)	21.0 IN (533.4 MM)	03/26/99	E.V.
464-074-514-D	121-410-010	7.0 FT (2.1 M)	21.0 IN (533.4 MM)	21.0 IN (533.4 MM)	03/26/99	E.V.
464-074-513-D	121-410-000	7.0 FT (2.1 M)	21.0 IN (533.4 MM)	21.0 IN (533.4 MM)	03/26/99	E.V.
464-054-512-D	121-410-023	5.0 FT (1.5 M)	17.0 IN (431.8 MM)	17.0 IN (431.8 MM)	03/26/99	E.V.
464-054-511-D	121-410-013	5.0 FT (1.5 M)	17.0 IN (431.8 MM)	17.0 IN (431.8 MM)	03/26/99	E.V.
464-054-510-D	121-410-003	5.0 FT (1.5 M)	17.0 IN (431.8 MM)	17.0 IN (431.8 MM)	03/26/99	E.V.

TABULATION BLOCK

		I/O INTERCONNECT SANTA ANA, CALIFORNIA	
THIRD ANGLE PROJECTION		TITLE: 6P4C/6P4C COIL CABLE, STANDARD STYLE, CABLE ASSEMBLY	
UNLESS OTHERWISE NOTED: 1) DIMENSIONS ARE IN INCHES (MILLIMETER) 2) TOLERANCES: X.XX ± 0.25 (6.35)		PART NO: 464-XX4-SIX-D DWG NO: 464-XX4-SIX-D CUSTOMER: DIGI KEY	
SCALE: NONE		SHEET 1 OF 1	
2	*X' FT	SEE "TABULATION BLOCK"	MODULAR COIL CABLE, 26 AWG (7/34) BARE COPPER, 4 CONDUCTOR, UNSHIELDED, PVC JACKET, (SEE TABULATION BLOCK FOR COLOR).
1	2 PCS	325-641-50X	CONNECTOR, MODULAR PLUG, 6 POSITION, 4 CONDUCTOR, 50" AW, FLAT TYPE EXIT.
ITEM	QTY	MFG.	DESCRIPTION
CABLE ASSEMBLY PARTS LIST			

A B C D E F G H

THESE DIMENSIONS AND SPECIFICATIONS ARE THE SOLE PROPERTY OF I/O INTERCONNECT INC. U.S.A. AND SHALL NOT BE REPRODUCED, COPIED, OR USED IN ANY MANNER WITHOUT THE PRIOR WRITTEN CONSENT OF I/O INTERCONNECT INC. OR ITS AFFILIATED SUBSIDIARIES.

DWG. NO. XX4-50X-D	ZONE	REV. X1	DESCRIPTION CUSTOMER APPROVAL	DATE 03/25/99	APPROVED E.V.
		X2	ADD RETRACTED LENGTH	03/29/99	E.V.

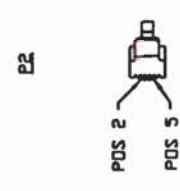
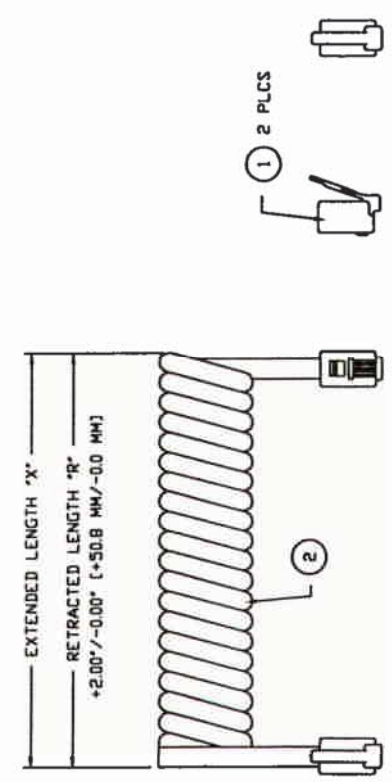

464-144-505-D	121-410-022	14.0 FT (4.3 M)	34.0 IN (863.6 MM)	WHITE
464-144-504-D	121-410-012	14.0 FT (4.3 M)	34.0 IN (863.6 MM)	BLACK
464-144-503-D	121-410-002	14.0 FT (4.3 M)	34.0 IN (863.6 MM)	SILVER SATIN
464-104-502-D	121-410-021	10.0 FT (3.0 M)	30.0 IN (762.0 MM)	WHITE
464-104-501-D	121-410-011	10.0 FT (3.0 M)	30.0 IN (762.0 MM)	BLACK
464-104-500-D	121-410-001	10.0 FT (3.0 M)	30.0 IN (762.0 MM)	SILVER SATIN
464-074-505-D	121-410-020	7.0 FT (2.1 M)	21.0 IN (533.4 MM)	WHITE
464-074-504-D	121-410-010	7.0 FT (2.1 M)	21.0 IN (533.4 MM)	BLACK
464-074-503-D	121-410-000	7.0 FT (2.1 M)	21.0 IN (533.4 MM)	SILVER SATIN
464-054-502-D	121-410-023	5.0 FT (1.5 M)	17.0 IN (431.8 MM)	WHITE
464-054-501-D	121-410-013	5.0 FT (1.5 M)	17.0 IN (431.8 MM)	BLACK
464-054-500-D	121-410-003	5.0 FT (1.5 M)	17.0 IN (431.8 MM)	SILVER SATIN
IOI PART NUMBER	IOI CABLE PART NUMBER	EXTENDED LENGTH "X"	RETRACTED LENGTH "R"	COLOR

CUSTOMER APPROVAL
ENGR. SIGN Y. Math Danner
DATE: 4-13-99

- NOTES: UNLESS OTHERWISE SPECIFIED.
1. TEST CABLE FOR ALL OPENS & SHORTS.
 2. PACKAGE CABLE ASSEMBLY INDIVIDUALLY IN PLASTIC BAG. PACKAGE INDIVIDUAL BAG PER LOT NUMBER QUANTITIES.

TABULATION BLOCK

THIRD ANGLE PROJECTION		I/O INTERCONNECT SANTA ANA, CALIFORNIA	
	UNLESS OTHERWISE NOTED DIMENSIONS ARE IN INCHES (MILLIMETER) TOLERANCES: .XXX ± .025 (6.35)	REV. NO.	464-XX4-50X-D
		DATE	4-13-99
		ENGR.	Y. MATH DANNER
		SCALE	NONE
		SHEET	1 OF 1

ITEM	QTY	MFG.	IOI PART NO.	DESCRIPTION
2		SEE "TABULATION BLOCK"		MODULAR COIL CABLE, 26 AWG (7/34) BARE COPPER, 4 CONDUCTOR, UNSHIELDED, PVC JACKET, (SEE TABULATION BLOCK FOR COLOR).
1	2 PCS	325-641-50X		CONNECTOR, MODULAR PLUG, 6 POSITION, 4 CONDUCTOR, 50u" Au, FLAT TYPE EXIT.

CABLE ASSEMBLY PARTS LIST

A	B	C	D	E	F	G	H	
THESE DRAWINGS AND SPECIFICATIONS ARE THE SOLE PROPERTY OF I/O INTERCONNECT INC. U.S.A. AND SHALL NOT BE REPRODUCED, COPIED, OR USED IN ANY MANNER WITHOUT THE PRIOR WRITTEN CONSENT OF I/O INTERCONNECT INC. OR ITS AFFILIATED SUBSIDIARIES.		DWG. NO. XX4-522-D		ZONE 	REV. X1	DESCRIPTION CUSTOMER APPROVAL	DATE 03/24/99	APPROVED E.V.

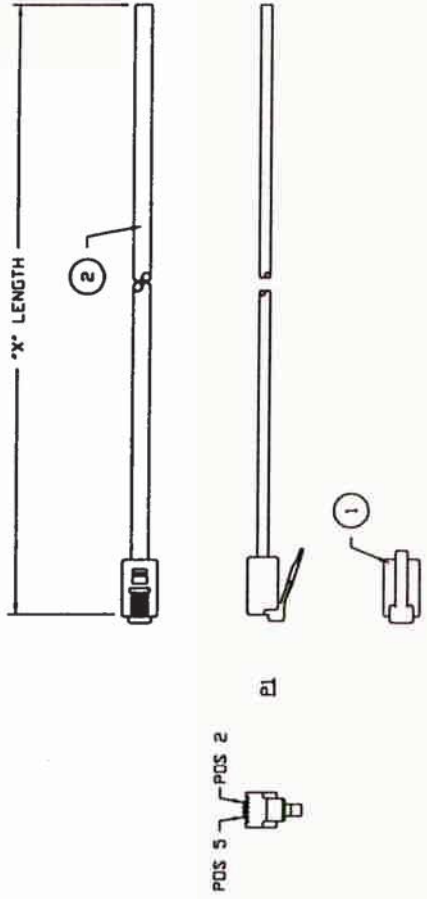

WIRE DIAGRAM

P1	BLACK	OPEN END
2	RED	
3	GREEN	
4	YELLOW	

CUSTOMER APPROVAL
 ENGR. SIGN Matt Lerner
 DATE: 4-12-99

- NOTES: UNLESS OTHERWISE SPECIFIED.
- CABLE TO BE BUNDLED AND TWIST TIED.
 - TEST CABLE FOR ALL OPENS & SHORTS.
 - PACKAGE CABLE ASSEMBLY INDIVIDUALLY IN PLASTIC BAG. PACKAGE INDIVIDUAL BAG PER LOT NUMBER QUANTITIES.

H3641-25-ND
 H3641-14-ND
 H3641-07-ND

464-254-522-D	25.0 FT ± 4.0 IN 7.62 M ± 101.6 MM
464-144-522-D	14.0 FT ± 3.0 IN 4.27 M ± 76.2 MM
464-074-522-D	7.0 FT ± 2.0 IN 2.13 M ± 50.8 MM
PART NUMBER I/O INTERCONNECT	LENGTH *X*

THIRD ANGLE PROJECTION

UNLESS OTHERWISE NOTED
 1) DIMENSIONS ARE IN INCHES (MILLIMETER)
 2) TOLERANCES:
 .XXX ± 0.25 (6.35)

I/O INTERCONNECT SANTA ANA, CALIFORNIA	
TITLE 6PAC MODULAR TO OPEN END, WHITE, CABLE ASSEMBLY	PART NO. 464-XX4-522-D
DRAWING NO. 464-XX4-522-D	CUSTOMER DIGI KEY
SCALE NONE	REV. X1

2	*X*	120-410-020	MODULAR CABLE, 26 AVG (7/34) BARE COPPER, 4 CONDUCTOR, UNSHIELDED, WHITE PVC.
1	1 PC	325-641-50X	CONNECTOR, MODULAR PLUG, 6 POSITION, 4 CONDUCTOR, 50" AW, FLAT TYPE EXIT.
ITEM	QTY	MFG.	DESCRIPTION
		IOI PART NO.	

CABLE ASSEMBLY PARTS LIST

SHEET 1	OF 1
---------	------

A	B	C	D	E	F	G	H
DWG. NO. XX4-521-D		ZONE REV. XI	DESCRIPTION CUSTOMER APPROVAL	DATE APPROVED 03/24/99	E.V.		

THESE DRAWINGS AND SPECIFICATIONS ARE THE SOLE PROPERTY OF I/O INTERCONNECT INC. NO PARTS OR INFORMATION HEREON ARE TO BE REPRODUCED OR TRANSMITTED IN ANY FORM OR BY ANY MEANS WITHOUT THE WRITTEN CONSENT OF I/O INTERCONNECT INC. OR ITS AFFILIATED SUBSIDIARIES.

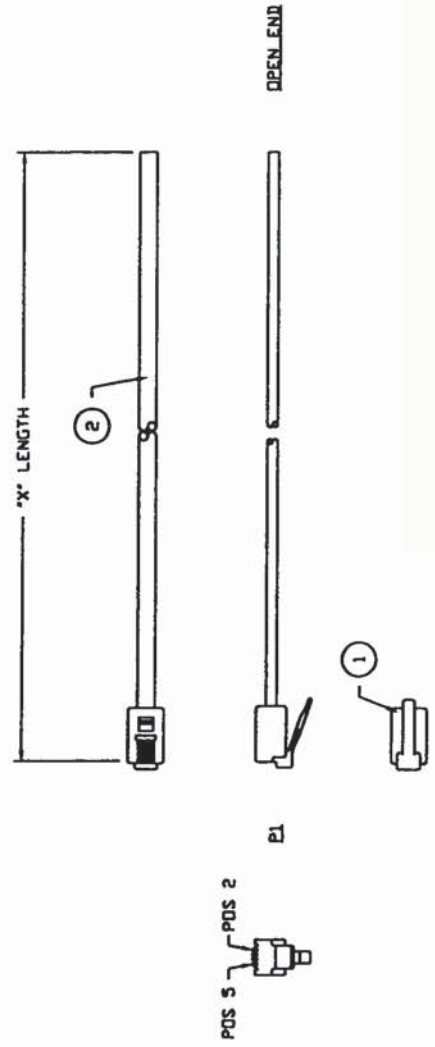

CUSTOMER APPROVAL
 ENGR. SIGN *Matt Armes*
 DATE: 4-12-99

H3642-25-ND
 H3642-14-ND
 H3642-07-ND

- NOTES: UNLESS OTHERWISE SPECIFIED.
1. CABLE TO BE BUNDLED AND TWIST TIED.
 2. TEST CABLE FOR ALL OPENS & SHORTS.
 3. PACKAGE CABLE ASSEMBLY INDIVIDUALLY IN PLASTIC BAG. PACKAGE INDIVIDUAL BAG PER LOT NUMBER QUANTITIES.

464-254-521-D	25.0 FT ± 4.0 IN 7.62 M ± 101.6 MM
464-144-521-D	14.0 FT ± 3.0 IN 4.27 M ± 76.2 MM
464-074-521-D	7.0 FT ± 2.0 IN 2.13 M ± 50.8 MM

I/O INTERCONNECT	
SANTA ANA, CALIFORNIA	
TITLE	6PAC MODULAR TO OPEN END, BLACK, CABLE ASSEMBLY
PART NO.	464-XX4-521-D
DWG. NO.	464-XX4-521-D
CUSTOMER	DIGI KEY
SCALE	NONE
SHEET	1 OF 1

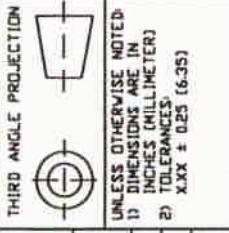

UNLESS OTHERWISE NOTED
 1) DIMENSIONS ARE IN INCHES (MILLIMETER)
 2) TOLERANCES:
 X.XX ± 0.25 (6.35)

ITEM	QTY	MFG.	IDI PART NO.	DESCRIPTION
2	1	IDI	120-410-010	MODULAR CABLE, 26 AVG (7/34) BARE COPPER, 4 CONDUCTOR, UNSHIELDED, BLACK PVC.
1	1	IDI	325-641-50X	CONNECTOR, MODULAR PLUG, 6 POSITION, 4 CONDUCTOR, 50U" AU, FLAT TYPE EXIT.

CABLE ASSEMBLY PARTS LIST

THESE DRAWINGS AND SPECIFICATIONS ARE THE SOLE PROPERTY OF I/O INTERCONNECT INC. NO PARTS MAY BE REPRODUCED OR TRANSMITTED IN ANY FORM OR BY ANY MEANS WITHOUT WRITTEN CONSENT OF I/O INTERCONNECT INC. OR ITS AFFILIATED SUBSIDIARIES.

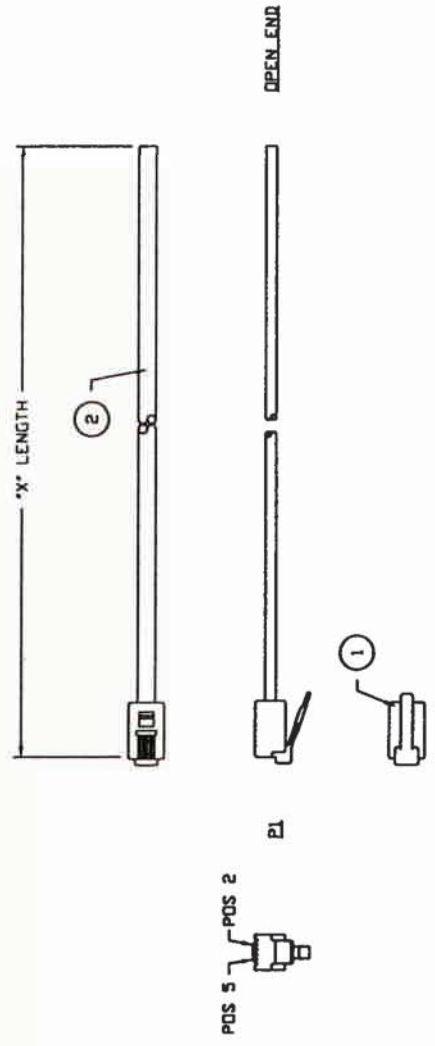

WIRE DIAGRAM

PI	OPEN END
2	BLACK
3	RED
4	GREEN
5	YELLOW

CUSTOMER APPROVAL
 ENGR. SIGN *Math Arnold*
 DATE: 4-12-99

- NOTES: UNLESS OTHERWISE SPECIFIED.
1. CABLE TO BE BUNDLED AND TWIST TIED.
 2. TEST CABLE FOR ALL OPENS & SHORTS.
 3. PACKAGE CABLE ASSEMBLY INDIVIDUALLY IN PLASTIC BAG. PACKAGE INDIVIDUAL BAG PER LOT NUMBER QUANTITIES.

H3643-25-ND
 H3643-14-ND
 H3643-07-ND

464-254-520-D	23.0 FT ± 4.0 IN 7.62 M ± 101.6 MM
464-144-520-D	14.0 FT ± 3.0 IN 4.27 M ± 76.2 MM
464-074-520-D	7.0 FT ± 2.0 IN 2.13 M ± 50.8 MM
PART NUMBER	LENGTH *X*
I/O INTERCONNECT	



UNLESS OTHERWISE NOTED
 1) DIMENSIONS ARE IN INCHES (MILLIMETER)
 2) TOLERANCES:
 X.XX ± 0.25 (6.35)

I/O INTERCONNECT	
SANTA ANA, CALIFORNIA	
TITLE	6P4C MODULAR TO OPEN END, SILVER SATIN, CABLE ASSEMBLY
PART NO.	464-XX4-520-D
REV.	464-XX4-520-D
CUSTOMER	DIGI KEY
SCALE	NONE
SHEET	1 OF 1

MODULAR CABLE, 26 AVG (7/34) BARE COPPER, 4 CONDUCTOR, UNSHIELDED, SILVER SATIN PVC.

CONNECTOR, MODULAR PLUG, 6 POSITION, 4 CONDUCTOR, 50u" AU, FLAT TYPE EXIT.

ITEM	QTY	MFG	IDI PART NO.	DESCRIPTION
2	1	IDI	120-410-000	MODULAR CABLE, 26 AVG (7/34) BARE COPPER, 4 CONDUCTOR, UNSHIELDED, SILVER SATIN PVC.
1	1	IDI	325-641-50X	CONNECTOR, MODULAR PLUG, 6 POSITION, 4 CONDUCTOR, 50u" AU, FLAT TYPE EXIT.

CABLE ASSEMBLY PARTS LIST

THESE DRAWINGS AND SPECIFICATIONS ARE THE SOLE PROPERTY OF I/O INTERCONNECT INC., U.S.A. AND SHALL NOT BE REPRODUCED, COPIED, OR USED IN ANY MANNER WITHOUT THE PRIOR WRITTEN CONSENT OF I/O INTERCONNECT INC. OR ITS AFFILIATED SUBSIDIARIES.

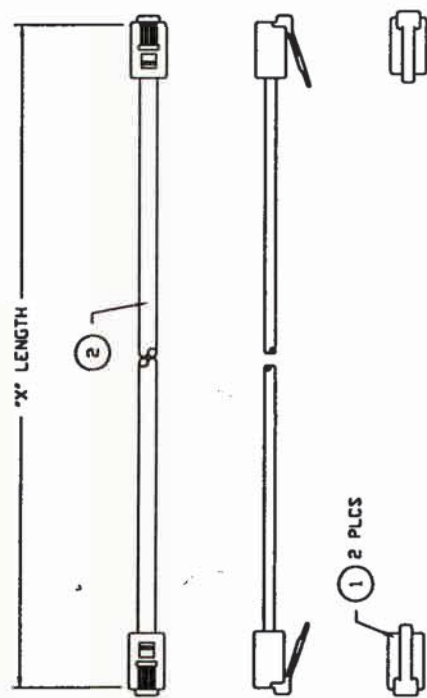

WIRE DIAGRAM

P1	BLACK	P2
2	RED	5
3	GREEN	4
4	YELLOW	3
5		2

CUSTOMER APPROVAL
ENGR. SIGN *Matt Linnell*
DATE: 4-12-99

H1641-25-ND
H1641-14-ND
H1641-07-ND

- NOTES: UNLESS OTHERWISE SPECIFIED.
1. CABLE TO BE BUNDLED AND TWIST TIED.
 2. TEST CABLE FOR ALL OPENS & SHORTS.
 3. PACKAGE CABLE ASSEMBLY INDIVIDUALLY IN PLASTIC BAG. PACKAGE INDIVIDUAL BAG PER LOT NUMBER QUANTITIES.

464-254-512-D	25.0 FT ± 4.0 IN 7.62 M ± 101.6 MM
464-144-512-D	14.0 FT ± 3.0 IN 4.27 M ± 76.2 MM
464-074-512-D	7.0 FT ± 2.0 IN 2.13 M ± 50.8 MM
PART NUMBER I/O INTERCONNECT	LENGTH "X"

I/O INTERCONNECT
SANTA ANA, CALIFORNIA

WIRE: 6P4C MODULAR, STANDARD STYLE, WHITE, CABLE ASSEMBLY

PART NO.: 464-XX4-512-D

DWG NO.: 464-XX4-512-D

CUSTOMER: DIGI KEY

REV. X1

SCALE: NONE SHEET 1 OF 1

THIRD ANGLE PROJECTION

UNLESS OTHERWISE NOTED DIMENSIONS ARE IN INCHES (MILLIMETER)

XXX ± 0.25 (6.35)

ITEM	QTY	MFG.	IOI PART NO.	DESCRIPTION
2	"X"	IOI	120-410-020	MODULAR CABLE, 26 AVG (7/34) BARE COPPER, 4 CONDUCTOR, UNSHIELDED, WHITE PVC
1	2 PCS	IOI	325-641-50X	CONNECTOR, MODULAR PLUG, 6 POSITION, 4 CONDUCTOR, 50U" AU, FLAT TYPE EXIT.

CABLE ASSEMBLY PARTS LIST

A	B	C	D	E	F	G	H
THESE DRAWINGS AND SPECIFICATIONS ARE THE SOLE PROPERTY OF I/O INTERCONNECT INC. USA AND SHALL NOT BE REPRODUCED, COPIED OR USED IN ANY MANNER WITHOUT THE PRIOR WRITTEN CONSENT OF I/O INTERCONNECT INC OR ITS AFFILIATED SUBSIDIARIES.		DWG. NO. XX4-511-D	ZONE	REV. X1	DESCRIPTION CUSTOMER APPROVAL	DATE 03/24/99	APPROVED E.V.

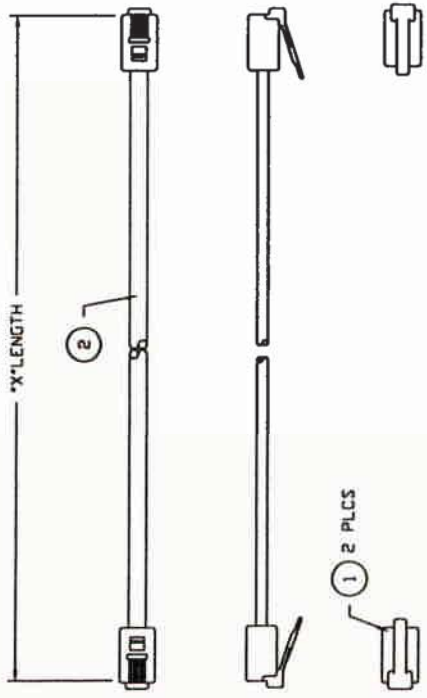

WIRE DIAGRAM

PL	PR
2	BLACK
3	RED
4	GREEN
5	YELLOW

CUSTOMER APPROVAL
ENGR. SIGN *Math Larmer*
DATE: 4-12-99

- NOTES: UNLESS OTHERWISE SPECIFIED.
- CABLE TO BE BUNDLED AND TWIST TIED.
 - TEST CABLE FOR ALL OPENS & SHORTS.
 - PACKAGE CABLE ASSEMBLY INDIVIDUALLY IN PLASTIC BAG. PACKAGE INDIVIDUAL BAG PER LOT NUMBER QUANTITIES.

464-254-511-D	25.0 FT ± 4.0 IN 7.62 M ± 101.6 MM
464-144-511-D	14.0 FT ± 3.0 IN 4.27 M ± 76.2 MM
464-074-511-D	7.0 FT ± 2.0 IN 2.13 M ± 50.8 MM
PART NUMBER	LENGTH "X"

THIRD ANGLE PROJECTION

UNLESS OTHERWISE NOTED
 1) DIMENSIONS ARE IN INCHES (MILLIMETER)
 2) TOLERANCES
 X.XX ± 0.25 (6.35)

I/O INTERCONNECT
 SANTA ANA, CALIFORNIA

6P4C MODULAR, STANDARD STYLE, BLACK, CABLE ASSEMBLY

PART NO. 464-XX4-511-D
 REV. X1

DIGI KEY

REV. X1

SHEET 1 OF 1

2	"X"	IDI	120-410-010	MODULAR CABLE, 26 AVG (7/34) BARE COPPER, 4 CONDUCTOR, UNSHIELDED, BLACK PVC.
1	2 PCS	IDI	325-641-50X	CONNECTOR, MODULAR PLUG, 6 POSITION, 4 CONDUCTOR, 50u" Au, FLAT TYPE EXIT.
ITEM	QTY	MFG.	IDI PART NO.	DESCRIPTION

CABLE ASSEMBLY PARTS LIST

A	B	C	D	E	F	G	H	
THESE DRAWINGS AND SPECIFICATIONS ARE THE SOLE PROPERTY OF I/O INTERCONNECT INC. ANY REPRODUCTION OR USE IN ANY MANNER WITHOUT THE WRITTEN CONSENT OF I/O INTERCONNECT INC. OR ITS AFFILIATED SUBSIDIARIES.		DWG. NO. XX4-502-D	REV. X1	DESCRIPTION CUSTOMER APPROVAL	DATE 03/24/99	APPROVED E.V.		

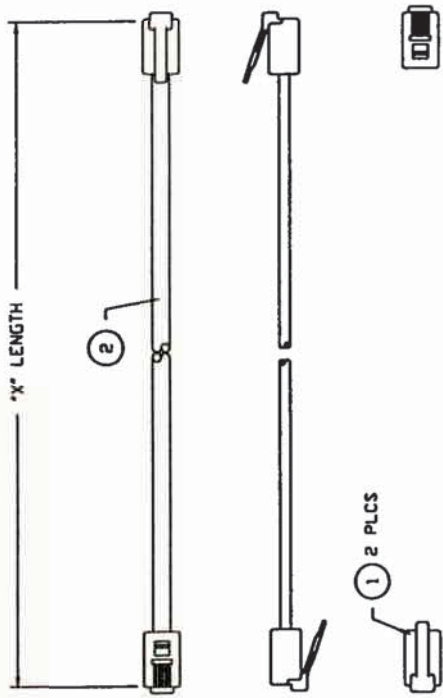

WIRE DIAGRAM

P1	BLACK	P2
2	RED	2
3	GREEN	3
4	YELLOW	4
5		5

CUSTOMER APPROVAL
 ENGR. SIGN Math Lopez
 DATE: 4-12-99

- NOTES: UNLESS OTHERWISE SPECIFIED.
- CABLE TO BE BUNDLED AND TWIST TIED.
 - TEST CABLE FOR ALL OPENS & SHORTS.
 - PACKAGE CABLE ASSEMBLY INDIVIDUALLY IN PLASTIC BAG. PACKAGE INDIVIDUAL BAG PER LOT NUMBER QUANTITIES.

464-254-502-D	25.0 FT ± 4.0 IN 7.62 M ± 101.6 MM
464-144-502-D	14.0 FT ± 3.0 IN 4.27 M ± 76.2 MM
464-074-502-D	7.0 FT ± 2.0 IN 2.13 M ± 50.8 MM
PART NUMBER I/O INTERCONNECT	LENGTH 'X'

TITLE I/O INTERCONNECT SANTA ANA, CALIFORNIA	
IN. BY CHG. BY W. ENGRS.	REV. DATE
6P4C MODULAR, REVERT STYLE, WHITE, CABLE ASSEMBLY	
PART NO. 464-XX4-502-D	REV. 464-XX4-502-D
CUSTOMER I/O INTERCONNECT	REV. I/O INTERCONNECT
SCALE NONE	SHEET 1 OF 1

THIRD ANGLE PROJECTION 			
UNLESS OTHERWISE NOTED 1) DIMENSIONS ARE IN INCHES (MILLIMETERS) 2) TOLERANCES: X.XX ± 0.25 (6.35)			
ITEM 2	QTY 101	MFG. 120-410-020	DESCRIPTION MODULAR CABLE, 26 AVG (7/34) BARE COPPER, 4 CONDUCTOR, UNSHIELDED, WHITE PVC.
ITEM 1	QTY 101	MFG. 325-641-50X	DESCRIPTION CONNECTOR, MODULAR PLUG, 6 POSITION, 4 CONDUCTOR, 50U" AW, FLAT TYPE EXIT.
CABLE ASSEMBLY PARTS LIST			

THESE DRAWINGS AND SPECIFICATIONS ARE THE SOLE PROPERTY OF I/O INTERCONNECT INC. U.S. AND CANADA. NO PART OF THESE DRAWINGS OR SPECIFICATIONS MAY BE REPRODUCED OR TRANSMITTED IN ANY FORM OR BY ANY MEANS, ELECTRONIC OR MECHANICAL, INCLUDING PHOTOCOPYING, RECORDING, OR BY ANY INFORMATION STORAGE AND RETRIEVAL SYSTEM, WITHOUT THE WRITTEN CONSENT OF I/O INTERCONNECT INC. OR ITS AFFILIATED SUBSIDIARIES.

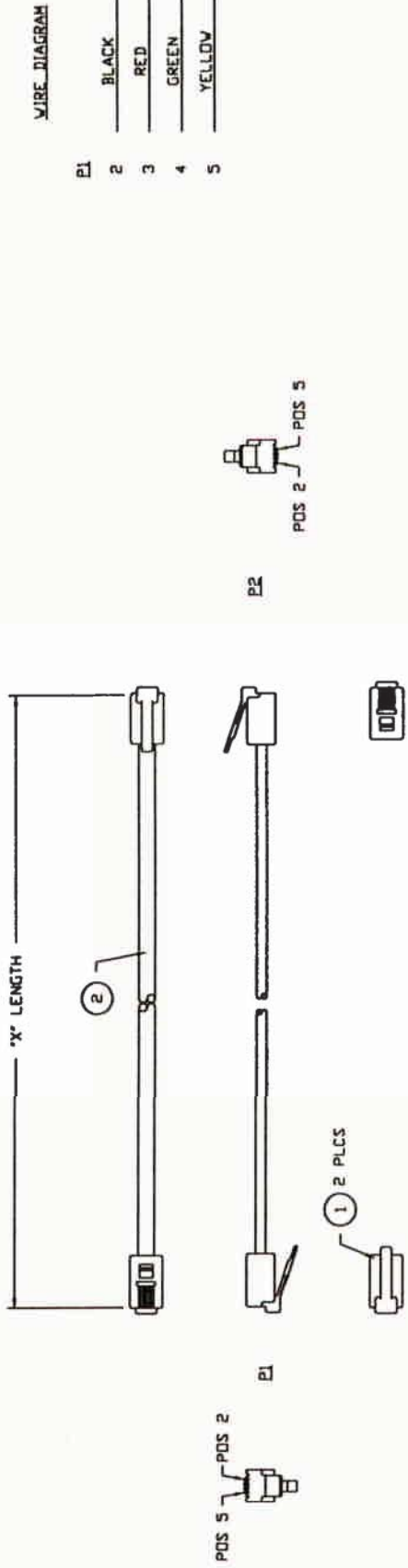

CUSTOMER APPROVAL
 ENGR. SIGN Y. Matt James
 DATE: 4-12-99

- NOTES: UNLESS OTHERWISE SPECIFIED.
- CABLE TO BE BUNDLED AND TWIST TIED.
 - TEST CABLE FOR ALL OPENS & SHORTS.
 - PACKAGE CABLE ASSEMBLY INDIVIDUALLY IN PLASTIC BAG. PACKAGE INDIVIDUAL BAG PER LOT NUMBER QUANTITIES.

H2642-25-ND
 H2642-14-ND
 H2642-07-ND

464-254-501-D	250 FT ± 4.0 IN 7.62 M ± 101.6 MM
464-144-501-D	14.0 FT ± 3.0 IN 4.27 M ± 76.2 MM
464-074-501-D	7.0 FT ± 2.0 IN 2.13 M ± 50.8 MM
PART NUMBER I/O_INTERCONNECT	LENGTH 'X'

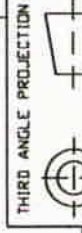

UNLESS OTHERWISE NOTED:
 1) DIMENSIONS ARE IN INCHES (MILLIMETER)
 2) TOLERANCES:
 .XXX ± 0.25 (6:3S)

TITLE I/O INTERCONNECT	
SANTA ANA, CALIFORNIA	
REV. NO.	REV. STYLE
6P4C MODULAR, REVERT STYLE.	BLACK, CABLE ASSEMBLY
PART NO.	464-XX4-501-D
DWG. NO.	464-XX4-501-D
CUSTOMER	DIGI KEY
CERT. FILED	REV. XI
SCALE	NONE
SHEET	1 OF 1

ITEM	QTY	MFG.	IOI PART NO.	DESCRIPTION
2	'X'	IOI	120-410-010	MODULAR CABLE, 26 AVG (7/34) BARE COPPER, 4 CONDUCTOR, UNSHIELDED, BLACK PVC.
1	2 PCS	IOI	325-641-50X	CONNECTOR, MODULAR PLUG, 6 POSITION, 4 CONDUCTOR, 50U' ALL, FLAT TYPE EXIT.

CABLE ASSEMBLY PARTS LIST

A	B	C	D	E	F	G	H
THESE DRAWINGS AND SPECIFICATIONS ARE THE SOLE PROPERTY OF I/O INTERCONNECT INC. U.S.A. AND SHALL NOT BE REPRODUCED, COPIED, OR USED IN ANY MANNER WITHOUT THE WRITTEN CONSENT OF I/O INTERCONNECT INC OR ITS AFFILIATED SUBSIDIARIES.		DWG. NO. XX4-500-D	ZONE	REV. X1	DESCRIPTION CUSTOMER APPROVAL	DATE 03/24/99	APPROVED E.V.

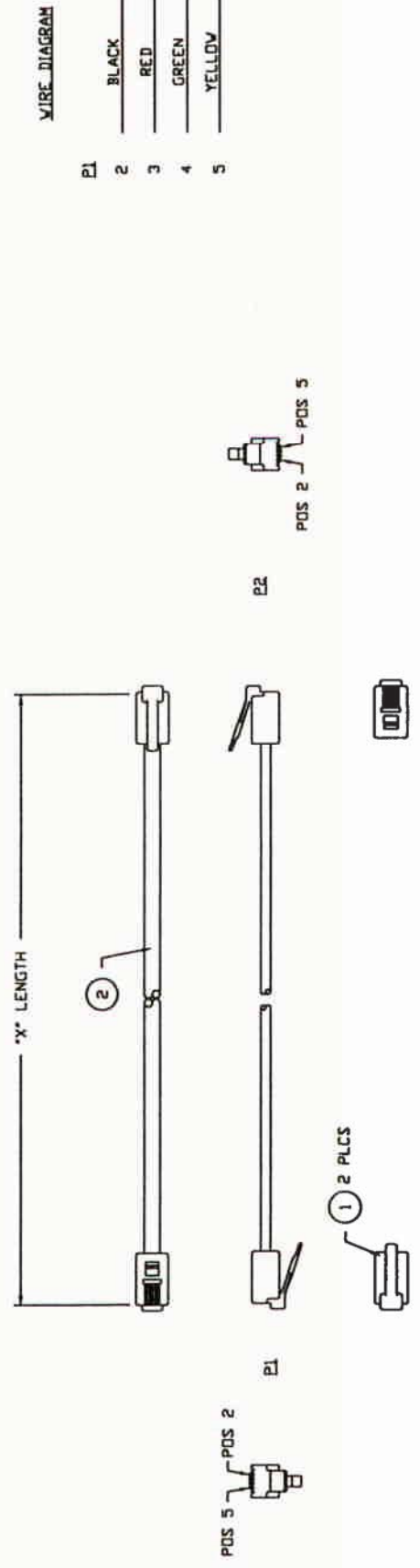

CUSTOMER APPROVAL
 ENGR. SIGN Matt Lammie
 DATE: 4-12-99

- NOTES: UNLESS OTHERWISE SPECIFIED.
- CABLE TO BE BUNDLED AND TWIST TIED.
 - TEST CABLE FOR ALL OPENS & SHORTS.
 - PACKAGE CABLE ASSEMBLY INDIVIDUALLY IN PLASTIC BAG. PACKAGE INDIVIDUAL BAG PER LOT NUMBER QUANTITIES.

H2643-25-ND
 H2643-14-ND
 H2643-07-ND

464-254-500-D	25.0 FT ± 4.0 IN 7.62 M ± 101.6 MM
464-144-500-D	14.0 FT ± 3.0 IN 4.27 M ± 76.2 MM
464-074-500-D	7.0 FT ± 2.0 IN 2.13 M ± 50.8 MM
PART NUMBER	LENGTH "X"

THIRD ANGLE PROJECTION

UNLESS OTHERWISE NOTED:
 1) DIMENSIONS ARE IN INCHES (MILLIMETER)
 2) TOLERANCES:
 .XXX ± 0.25 (6.35)

I/O INTERCONNECT
 SANTA ANA, CALIFORNIA

TITLE	6P4C MODULAR, REVERT STYLE, SILVER SATIN, CABLE ASSEMBLY
PART NO.	464-XX4-500-D
DWG. NO.	464-XX4-500-D
CUSTOMER	DIGI KEY
SCALE	NONE
SHEET	1 OF 1

ITEM	QTY	MFG.	IDI PART NO.	DESCRIPTION
2	*X*	IDI	120-410-000	MODULAR CABLE, 26 AVG (7/34) BARE COPPER, 4 CONDUCTOR, UNSHIELDED, SILVER SATIN PVC.
1	2 PCS	IDI	325-641-50X	CONNECTOR, MODULAR PLUG, 6 POSITION, 4 CONDUCTOR, 50U* Au, FLAT TYPE EXIT.

CABLE ASSEMBLY PARTS LIST