

DATA SHEET

SKY67101-396LF: 0.4-1.2 GHz High Linearity, Active Bias Low-Noise Amplifier

Applications

- GSM, CDMA, WCDMA, and TD-SCDMA cellular infrastructure
- Ultra low-noise systems

Features

- Ultra Low Noise Figure: 0.57 dB @ 0.9 GHz
- Input and output return loss > 18 dB @ 0.9 GHz
- High OIP3 performance: +33.8 dBm @ 0.9 GHz
- Adjustable supply current and gain
- Temperature and process-stable active bias
- Miniature DFN (8-pin, 2 x 2 mm) package (MSL1 @ 260 °C per JEDEC J-STD-020)



Skyworks Green™ products are compliant with all applicable legislation and are halogen-free. For additional information, refer to *Skyworks Definition of Green™*, document number SQ04-0074.

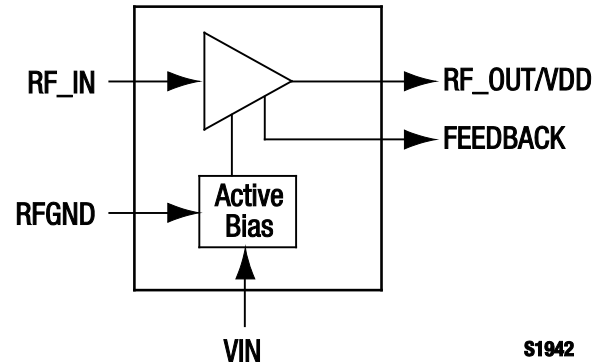

Figure 1. SKY67101-396LF Block Diagram

Description

The SKY67101-396LF is GaAs, pHEMT Low-Noise Amplifier (LNA) with an active bias and high linearity performance. The advanced GaAs pHEMT enhancement mode process provides excellent return loss, low noise, and high linearity performance.

The internal active bias circuitry provides stable performance over temperature and process variation. The device offers the ability to externally adjust supply current and gain. Supply voltage is applied to the RFOUT/VDD pin through an RF choke inductor. Pin 4 (VIN) should be connected to RFOUT/VDD through an external resistor to control the supply current. The RFIN and RFOUT/VDD pins should be DC blocked to ensure proper operation. Pin 5 (FEEDBACK) is connected through an RC network to externally adjust the gain of the device without affecting the Noise Figure (NF) of the LNA.

The SKY67101-396LF operates in the frequency range of 0.4 to 1.2 GHz with proper tuning. For higher frequency operation, the pin-compatible SKY67100-396LF should be used.

The LNA is manufactured in a compact, 2 x 2 mm, 8-pin Dual Flat No-Lead (DFN) package. A functional block diagram is shown in Figure 1. The pin configuration and package are shown in Figure 2. Signal pin assignments and functional pin descriptions are provided in Table 1.

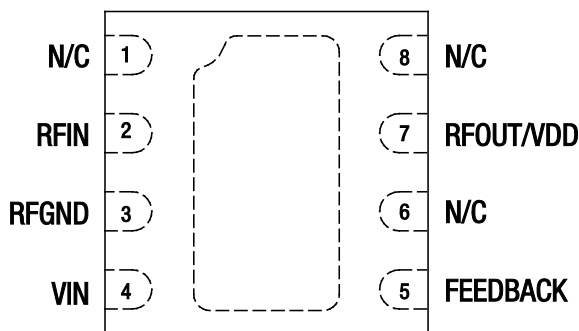

Figure 2. SKY67101-396LF Pinout – 8-Pin DFN (Top View)

Table 1. SKY67101-396LF Signal Descriptions

Pin #	Name	Description	Pin #	Name	Description
1	N/C	No connection. May be connected to ground with no change in performance.	5	FEEDBACK	LNA external gain control. Connect to RFOUT using a series RD network.
2	RFIN	RF input. DC blocking capacitor required.	6	N/C	No connection. May be connected to ground with no change in performance.
3	RFGND	RF ground. Connect to ground through a capacitor.	7	RFOUT/VDD	RF output. Apply VDD through RF choke inductor. DC blocking capacitor required.
4	VIN	LNA supply current. Connect through series resistor to VDD.	8	N/C	No connection. May be connected to ground with no change in performance.

Table 2. SKY67101-396LF Absolute Maximum Ratings

Parameter	Symbol	Minimum	Typical	Maximum	Units
Supply voltage	V _{DD}			5.5	V
Supply current	I _{DD}			100	mA
RF input power	P _{IN}			+20	dBm
Storage temperature	T _{STG}	-65	+25	+125	°C
Operating temperature	T _A	-40	+25	+85	°C
Junction temperature	T _J			+150	°C

Notes: Exposure to maximum rating conditions for extended periods may reduce device reliability. There is no damage to device with only one parameter set at the limit and all other parameters set at or below their nominal value. Exceeding any of the limits listed here may result in permanent damage to the device.
 Thermal resistance = 80 °C/W @ 4 V bias.

CAUTION: Although this device is designed to be as robust as possible, Electrostatic Discharge (ESD) can damage this device. This device must be protected at all times from ESD. Static charges may easily produce potentials of several kilovolts on the human body or equipment, which can discharge without detection. Industry-standard ESD precautions should be used at all times. The SKY67101-396LF is a Human Body Model (HBM) Class A ESD device.

Electrical and Mechanical Specifications

The absolute maximum ratings of the SKY67101-396LF are provided in Table 2. Electrical specifications are provided in Table 3.

Typical performance characteristics of the SKY67101-396LF are illustrated in Figures 3 through 14.

Table 3. SKY67101-396LF Electrical Specifications (Note 1)**(V_{DD} = 4.0 V, I_{DD} = 56 mA, T_A = +25 °C, P_{IN} = -20 dBm, Characteristic Impedance [Z₀] = 50 Ω, Thermal Resistance = 80 °C/W, Unless Otherwise Noted)**

Parameter	Symbol	Test Condition	Min	Typical	Max	Units
RF Specifications						
Noise Figure (Note 2)	NF	@ 0.80 GHz @ 0.85 GHz @ 0.90 GHz		0.63 0.59 0.57	1.00	dB dB dB
Small signal gain	IS21I	@ 0.80 GHz @ 0.85 GHz @ 0.9 GHz	17.7 17.0 16.6	18.7 18.0 17.6	19.7 19.0 18.6	dB dB dB
Input return loss	IS11I	@ 0.80 GHz @ 0.85 GHz @ 0.9 GHz		17.2 18.8 18.2		dB dB dB
Output return loss	IS22I	@ 0.80 GHz @ 0.85 GHz @ 0.9 GHz		19.8 33.0 20.0		dB dB dB
Reverse isolation	IS12I	@ 0.80 GHz @ 0.85 GHz @ 0.9 GHz		30.5 30.3 30.3		dB dB dB
3 rd Order Input Intercept Point	IIP3	@ 0.9 GHz, Δf = 5 MHz, P _{IN} = -20 dBm/tone		+16.2		dBm
3 rd Order Output Intercept Point	OIP3	@ 0.9 GHz, Δf = 5 MHz, P _{IN} = -20 dBm/tone	+32.5	+33.8		dBm
1 dB Input Compression Point	IP1dB	@ 0.9 GHz		+2.6		dBm
1 dB Output Compression Point	OP1dB	@ 0.9 GHz		+19.2		dBm
Stability	u1, u2	Up to 18 GHz, -40 °C to +85 °C		>1		-
DC Specifications						
Supply voltage	V _{DD}			4		V
Supply current	I _{DD}	Set with external resistor		56		mA

Note 1: Performance is guaranteed only under the conditions listed in this Table.**Note 2:** Loss from the input SMA connector and Evaluation Board up to component C1 has been de-embedded from the NF measurement.

Typical Performance Characteristics

(V_{DD} = 4.0 V, I_{DD} = 56 mA, T_A = +25 °C, P_{IN} = -20 dBm, Characteristic Impedance [Z₀] = 50 Ω, Thermal Resistance = 80 °C/W, Unless Otherwise Noted)

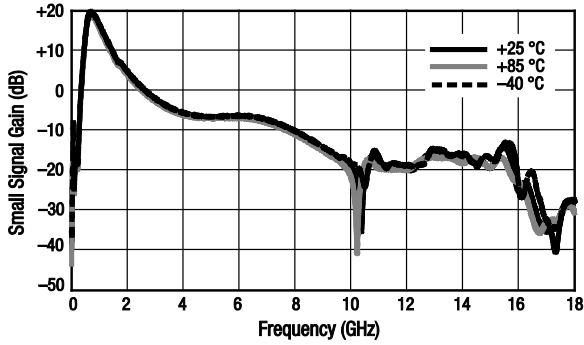

Figure 3. Broadband Gain Response vs Frequency

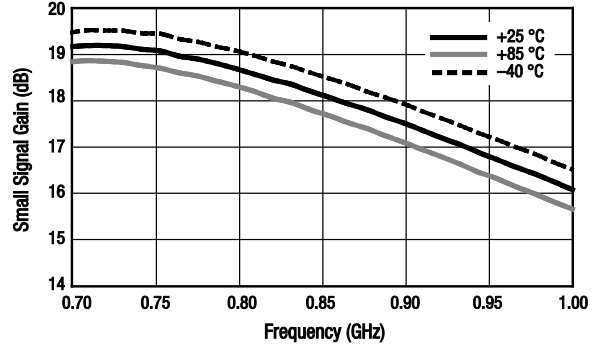

Figure 4. Narrowband Gain Response vs Frequency

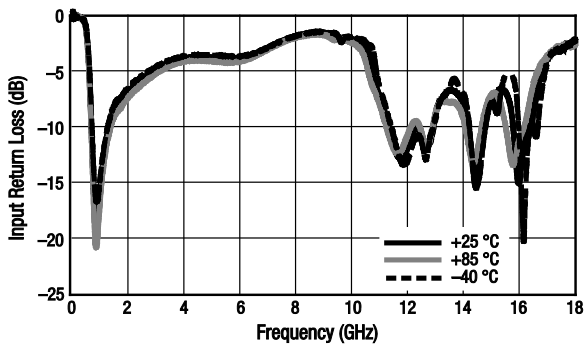

Figure 5. Broadband Input Return Loss vs Frequency

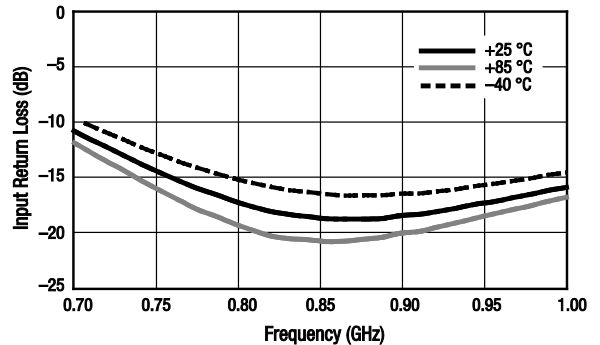

Figure 6. Narrowband Input Return Loss vs Frequency

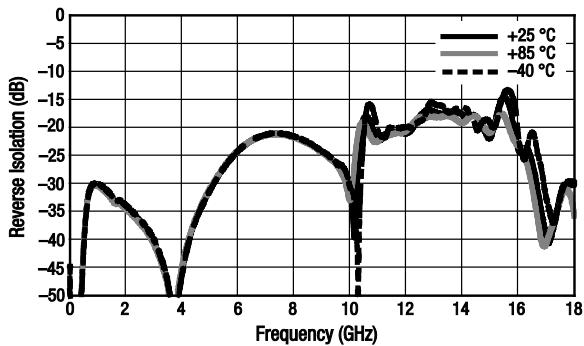

Figure 7. Broadband Reverse Isolation vs Frequency

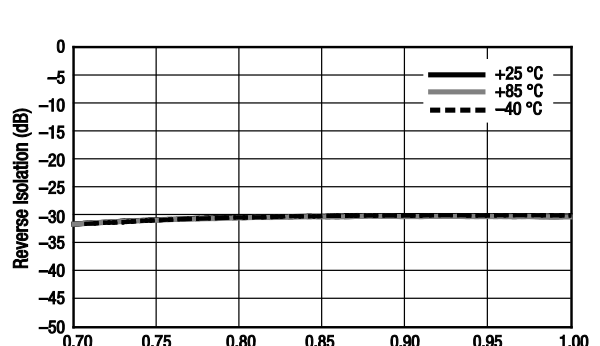

Figure 8. Narrowband Reverse Isolation vs Frequency

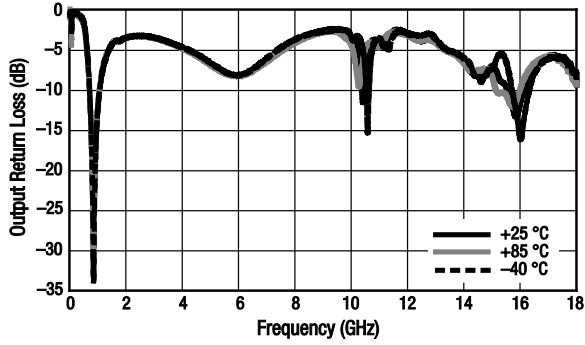

Figure 9. Broadband Output Return Loss vs Frequency

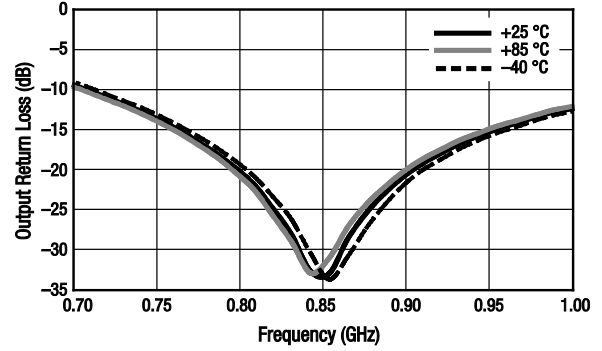

Figure 10. Narrowband Output Return Loss vs Frequency

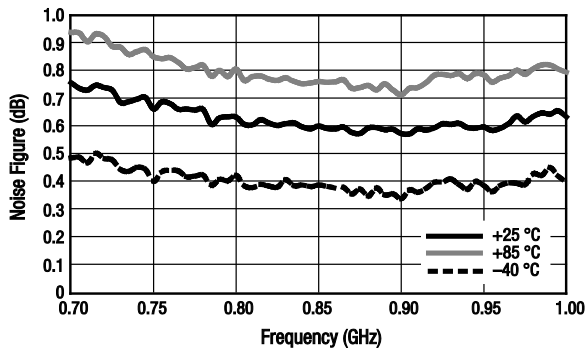

Figure 11. Noise Figure vs Frequency

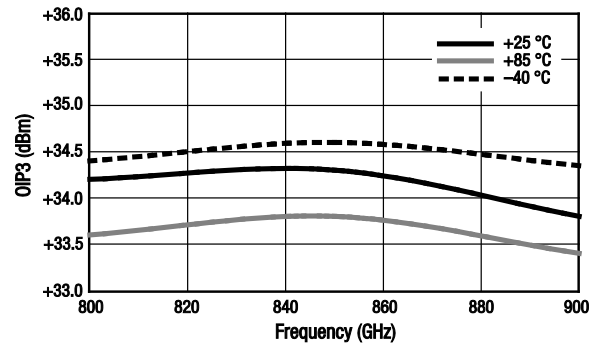

Figure 12. OIP3 vs Frequency
($P_{IN} = -20$ dBm, Spacing = 5 MHz)

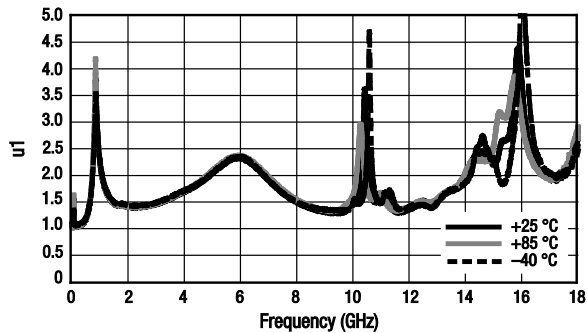

Figure 13. u1 Stability vs Frequency

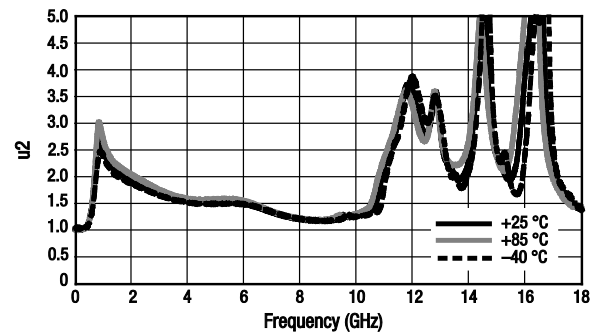

Figure 14. u2 Stability vs Frequency

Evaluation Board Description

The SKY67101-396LF Evaluation Board is used to test the performance of the SKY67101-396LF LNA. An assembly drawing for the Evaluation Board is shown in Figure 15. An Evaluation Board schematic diagram is provided in Figure 16. Table 4 provides the Bill of Materials (BOM) list for Evaluation Board components.

The test board uses a 10 mil Rogers 4350B substrate on a 50 mil FR4 supporting substrate. The Rogers 4350B material was selected for the RF circuit because of its low dielectric constant (ϵ_r) and low ϵ_r variation over temperature for the best possible noise performance.

Package Dimensions

The PCB layout footprint for the SKY67101-396LF is provided in Figure 17. Typical case markings are shown in Figure 18. Package dimensions for the 8-pin DFN are shown in Figure 19, and tape and reel dimensions are provided in Figure 20.

Package and Handling Information

Instructions on the shipping container label regarding exposure to moisture after the container seal is broken must be followed. Otherwise, problems related to moisture absorption may occur when the part is subjected to high temperature during solder assembly.

THE SKY67101-396LF is rated to Moisture Sensitivity Level 1 (MSL1) at 260 °C. It can be used for lead or lead-free soldering. For additional information, refer to the Skyworks Application Note, *Solder Reflow Information*, document number 200164.

Care must be taken when attaching this product, whether it is done manually or in a production solder reflow environment. Production quantities of this product are shipped in a standard tape and reel format.

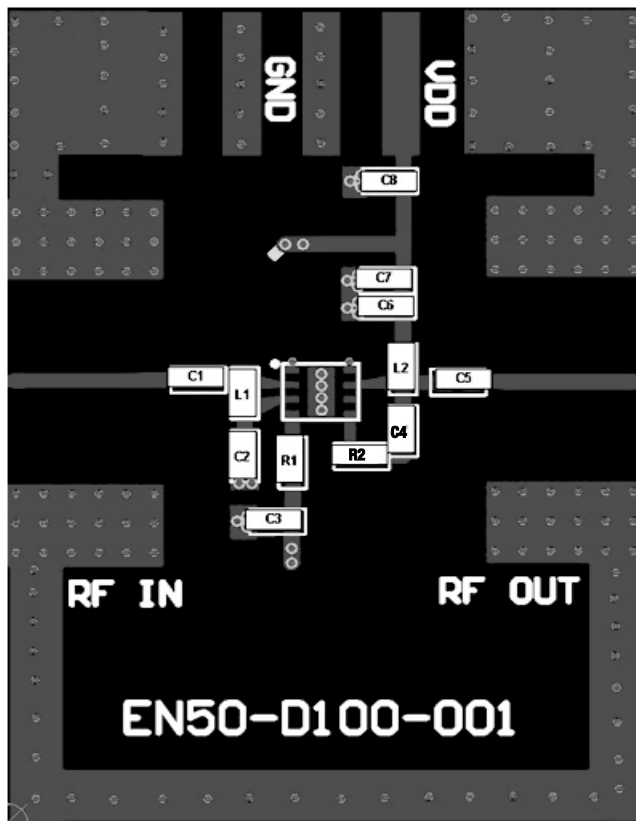

Figure 15. SKY67101-396LF Evaluation Board Assembly Diagram

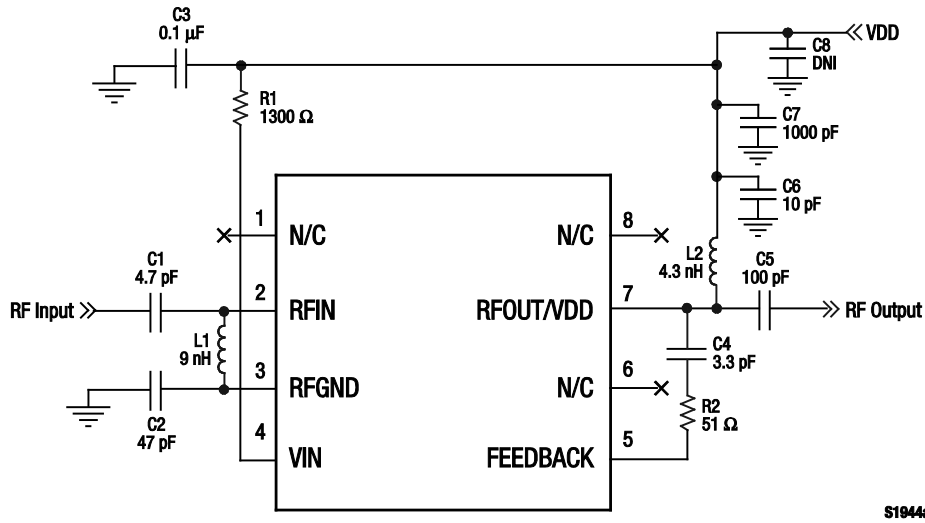
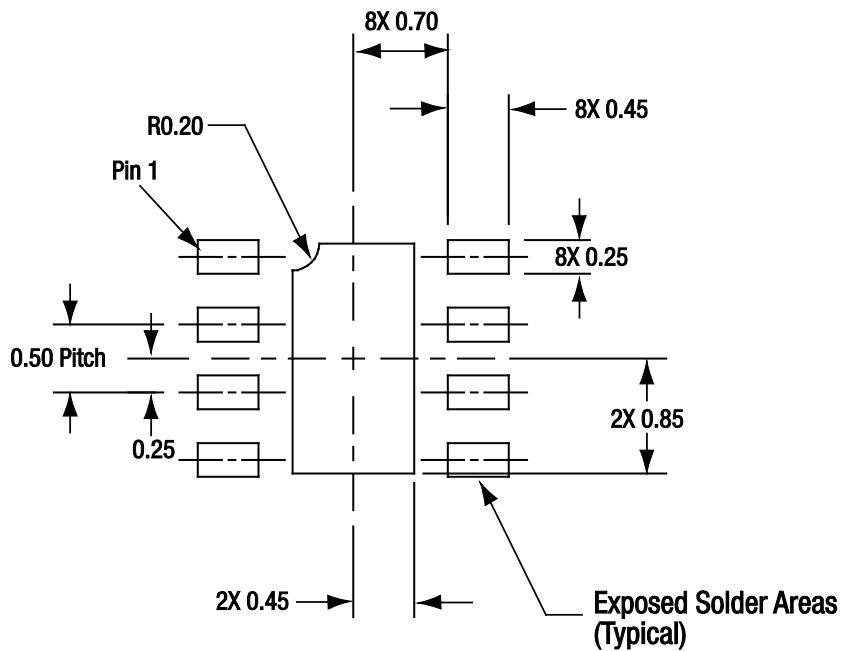

Figure 16. SKY67101-396LF Evaluation Board Schematic

Table 4. SKY67101-396LF Evaluation Board Bill of Materials

Component	Value	Size	Manufacturer
C1	4.7 pF	SMT 0402	Murata GJM (high Q)
C2	47 pF	SMT 0402	Murata GRM
C3	0.1 μF	SMT 0402	Murata GRM
C4	3.3 pF	SMT 0402	Murata GRM
C5	100 pF	SMT 0402	Murata GRM
C6	10 pF	SMT 0402	Murata GRM
C7	1000 pF	SMT 0402	Murata GRM
C8	–	–	Do not populate
L1	9 nH	SMT 0402	Coilcraft HP
L2	4.3 nH	SMT 0402	TDK MLG
R1	1300 Ω	SMT 0402	Panasonic
R2	51 Ω	SMT 0402	Panasonic



All dimensions are in millimeters

S1413

Figure 17. SKY67101-396LF PCB Layout Footprint (Top View)

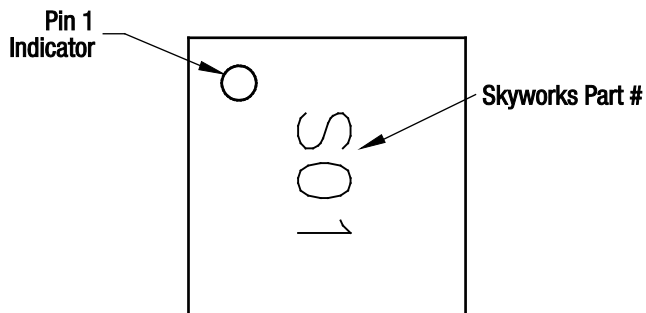
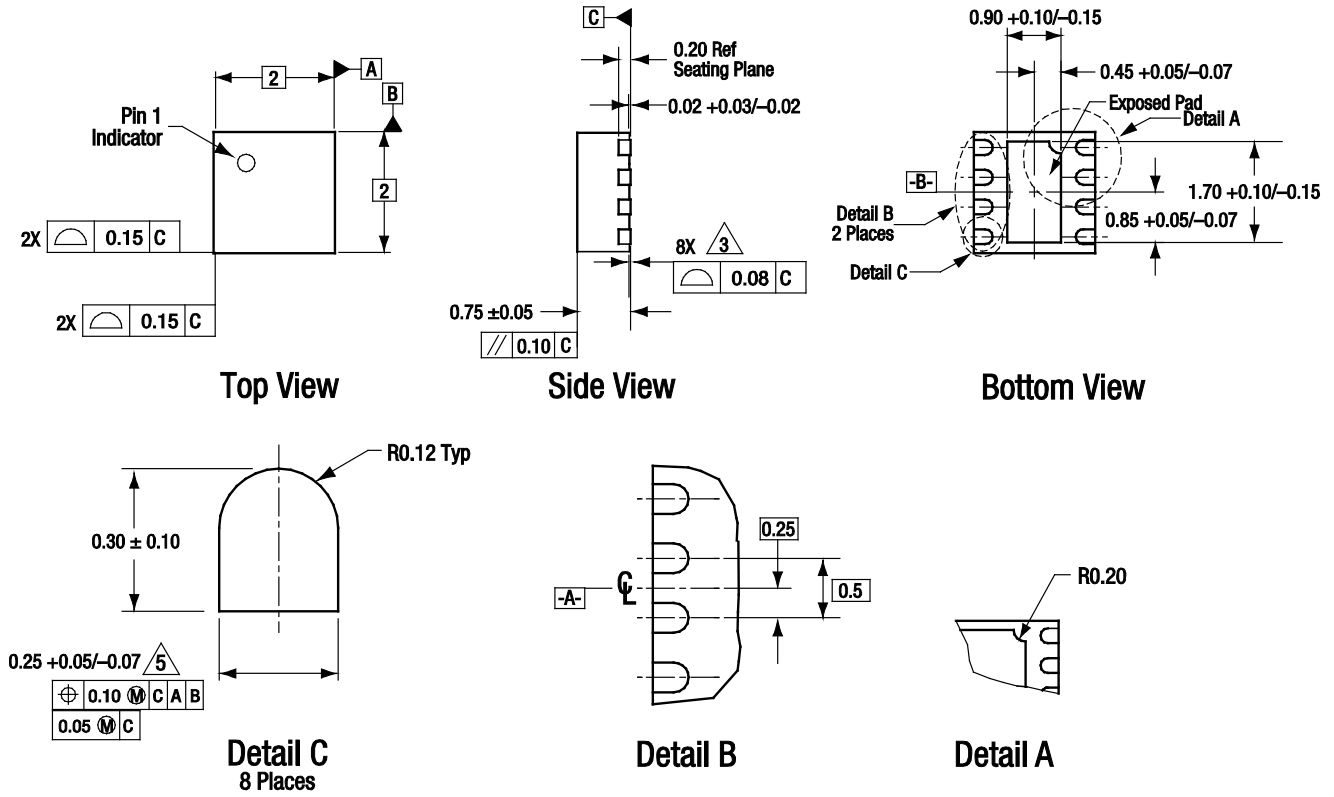

Figure 18. Typical Case Markings (Top View)



All measurements are in millimeters.
 Dimensioning and tolerancing according to ASME Y14.5M-1994.
 Coplanarity applies to the exposed heat sink slug as well as the terminals.
 Plating requirement per source control drawing (SCD) 2504.
 Dimension applies to metallized terminal and is measured between 0.15 mm and 0.30 mm from terminal tip.

S1945

Figure 19. SKY67101-396LF 8-Pin DFN Package Dimensions

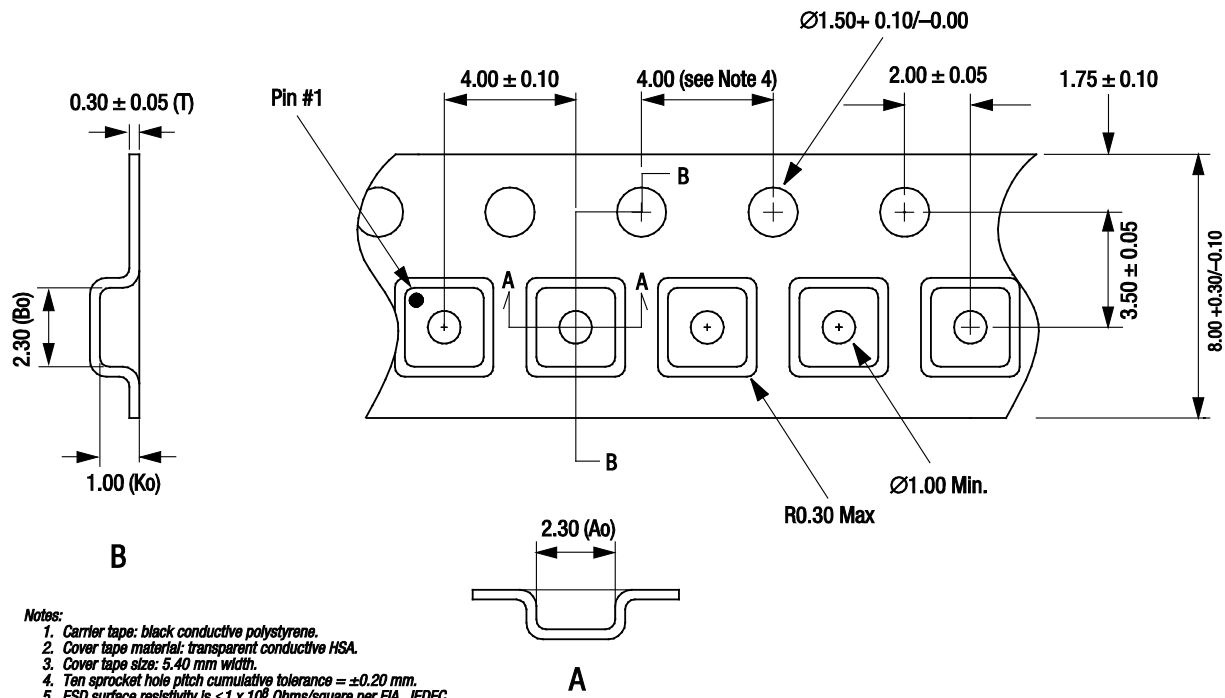

- Notes:
1. Carrier tape: black conductive polystyrene.
 2. Cover tape material: transparent conductive HSA.
 3. Cover tape size: 5.40 mm width.
 4. Ten sprocket hole pitch cumulative tolerance = ±0.20 mm.
 5. ESD surface resistivity is $\leq 1 \times 10^9$ Ohms/square per EIA, JEDEC tape and reel specification.
 6. Ao and Bo measurement point to be 0.30 mm from bottom pocket.
 7. All measurements are in millimeters.

S1601

Figure 20. SKY67101-396LF Tape and Reel Dimensions

Ordering Information

Model Name	Manufacturing Part Number	Evaluation Board Part Number
SKY67101-396LF LNA	SKY67101-396LF	SKY67101-396LF-EVB

Copyright © 2010, 2011 Skyworks Solutions, Inc. All Rights Reserved.

Information in this document is provided in connection with Skyworks Solutions, Inc. ("Skyworks") products or services. These materials, including the information contained herein, are provided by Skyworks as a service to its customers and may be used for informational purposes only by the customer. Skyworks assumes no responsibility for errors or omissions in these materials or the information contained herein. Skyworks may change its documentation, products, services, specifications or product descriptions at any time, without notice. Skyworks makes no commitment to update the materials or information and shall have no responsibility whatsoever for conflicts, incompatibilities, or other difficulties arising from any future changes.

No license, whether express, implied, by estoppel or otherwise, is granted to any intellectual property rights by this document. Skyworks assumes no liability for any materials, products or information provided hereunder, including the sale, distribution, reproduction or use of Skyworks products, information or materials, except as may be provided in Skyworks Terms and Conditions of Sale.

THE MATERIALS, PRODUCTS AND INFORMATION ARE PROVIDED "AS IS" WITHOUT WARRANTY OF ANY KIND, WHETHER EXPRESS, IMPLIED, STATUTORY, OR OTHERWISE, INCLUDING FITNESS FOR A PARTICULAR PURPOSE OR USE, MERCHANTABILITY, PERFORMANCE, QUALITY OR NON-INFRINGEMENT OF ANY INTELLECTUAL PROPERTY RIGHT; ALL SUCH WARRANTIES ARE HEREBY EXPRESSLY DISCLAIMED. SKYWORKS DOES NOT WARRANT THE ACCURACY OR COMPLETENESS OF THE INFORMATION, TEXT, GRAPHICS OR OTHER ITEMS CONTAINED WITHIN THESE MATERIALS. SKYWORKS SHALL NOT BE LIABLE FOR ANY DAMAGES, INCLUDING BUT NOT LIMITED TO ANY SPECIAL, INDIRECT, INCIDENTAL, STATUTORY, OR CONSEQUENTIAL DAMAGES, INCLUDING WITHOUT LIMITATION, LOST REVENUES OR LOST PROFITS THAT MAY RESULT FROM THE USE OF THE MATERIALS OR INFORMATION, WHETHER OR NOT THE RECIPIENT OF MATERIALS HAS BEEN ADVISED OF THE POSSIBILITY OF SUCH DAMAGE.

Skyworks products are not intended for use in medical, lifesaving or life-sustaining applications, or other equipment in which the failure of the Skyworks products could lead to personal injury, death, physical or environmental damage. Skyworks customers using or selling Skyworks products for use in such applications do so at their own risk and agree to fully indemnify Skyworks for any damages resulting from such improper use or sale.

Customers are responsible for their products and applications using Skyworks products, which may deviate from published specifications as a result of design defects, errors, or operation of products outside of published parameters or design specifications. Customers should include design and operating safeguards to minimize these and other risks. Skyworks assumes no liability for applications assistance, customer product design, or damage to any equipment resulting from the use of Skyworks products outside of stated published specifications or parameters.

Skyworks, the Skyworks symbol, and "Breakthrough Simplicity" are trademarks or registered trademarks of Skyworks Solutions, Inc., in the United States and other countries. Third-party brands and names are for identification purposes only, and are the property of their respective owners. Additional information, including relevant terms and conditions, posted at www.skyworksinc.com, are incorporated by reference.